



Being a Patent Attorney

IB Skills Conference

18th May 2016

Aim of Today's Talk

- Insight into what a patent attorney does and whether this might be the job for you
 - What are Intellectual Property Rights (IPRs)?
 - What does the job involve, skills needed?
 - How to enter the profession

- **Intellectual property (IP)** is a legal term that refers to creations of the mind. Examples of intellectual property include music, literature, and other artistic works; discoveries and inventions; and words, phrases, symbols, and designs.
- Under intellectual property laws, owners of intellectual property are granted certain exclusive rights.

IPR – Intellectual Property Rights

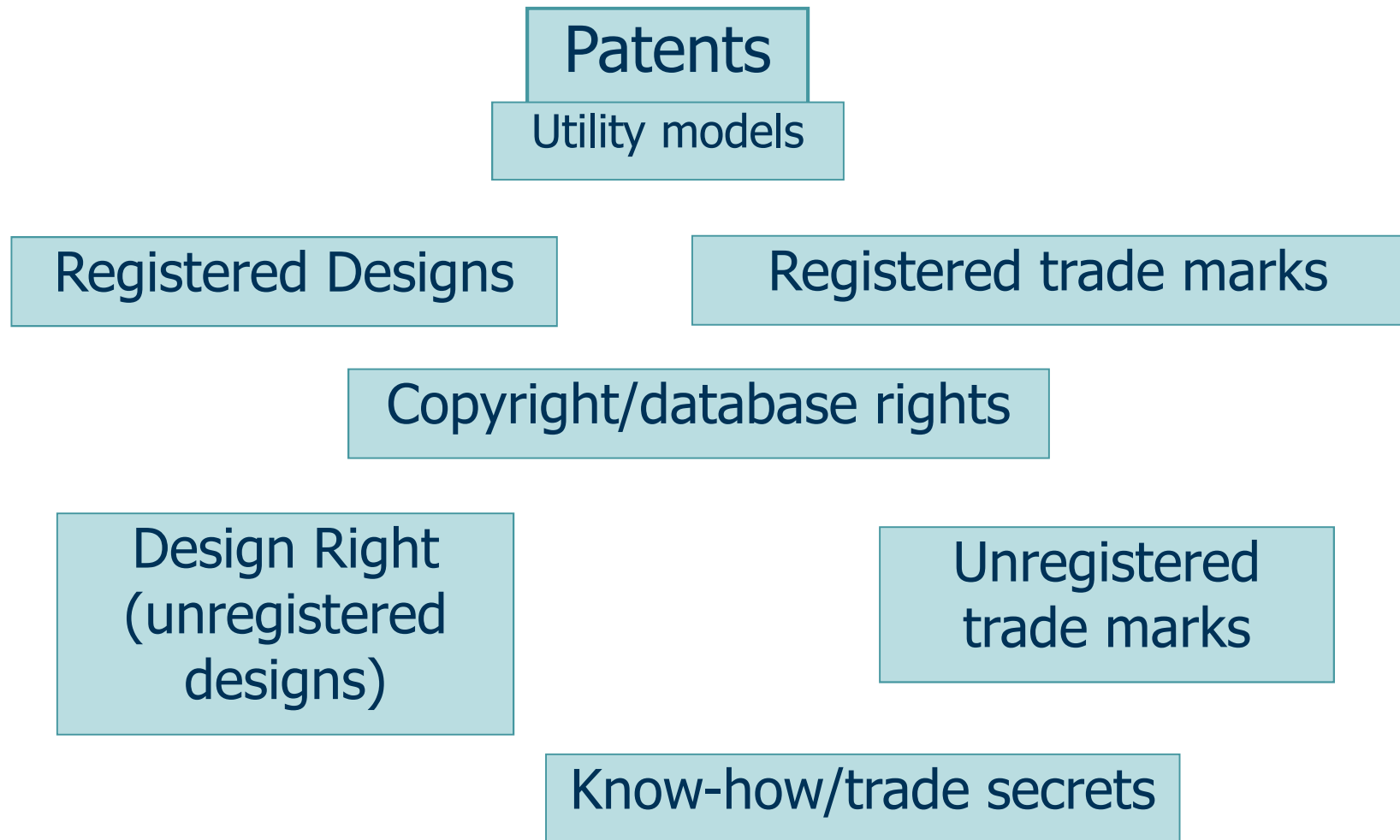

Commercial value of IP



ARM Holdings profits up 13%
(2014; £411m pre-tax profit)



AstraZeneca 

Lipitor[®] - cholesterol-lowering statin
Earned Pfizer \$12.5bn (£8bn) in 2008

The patent expired in 2011

Crestor[®] patent expires 2016, but cheap generic "Lipitor" could damage sales



Coke world's most valuable brand until 2013 – now 3rd at \$81.6bn
(2014; Interbrand[®])

- An invention is new if it is not part of the state of the art
...which means everything made available to the public before the patent filing date
- An invention involves an inventive step if it is not obvious to a skilled person in view of the state of the art
 - Who is the “skilled person”?
 - Beware of hindsight analysis

Patents – How do we get them?

File application

Search stage

Examination stage

Grant

Duration of process 2-5 years

Publication 18m after filing

Patents – parts of a specification

Title

Background

Statements of invention

Detailed description/examples

Claims

Abstract

Drawings

Patents – A real claim

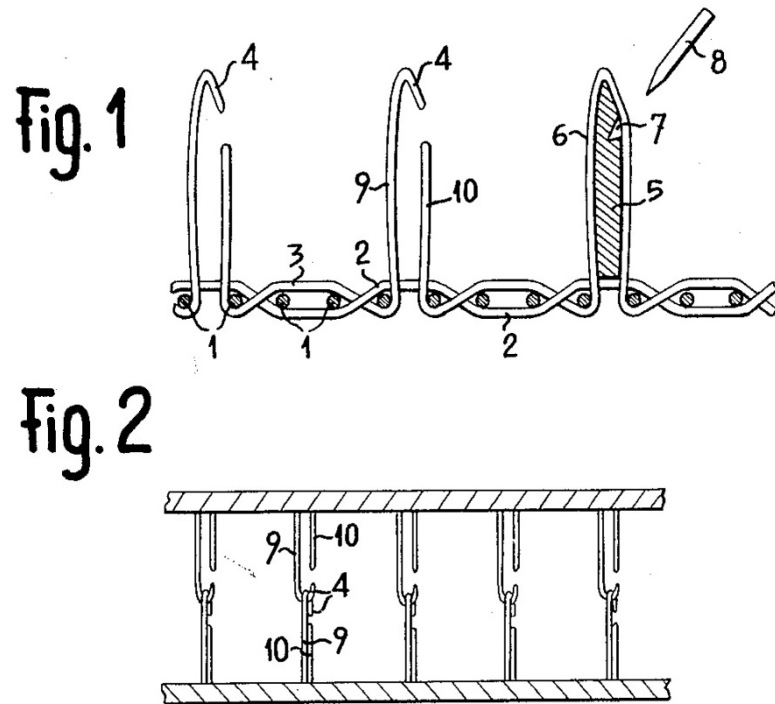

A velvet type fabric comprising a foundation structure including a plurality of weft threads, a plurality of warp threads, and a plurality of auxiliary warp threads of a synthetic resin material in the form of raised pile threads, the ends of at least part of said raised pile threads being in the form of material-engaging hooks.

US2,717,437 – Granted 1955

Patents – Claims

1. Invention of broadest scope – comprising feature X
2. Invention according to claim 1 further comprising additional preferred feature Y

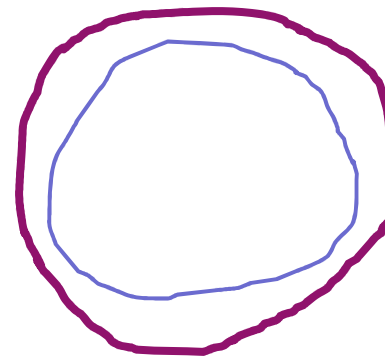
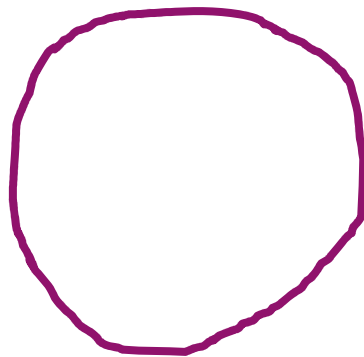

Patents – Examination of claims

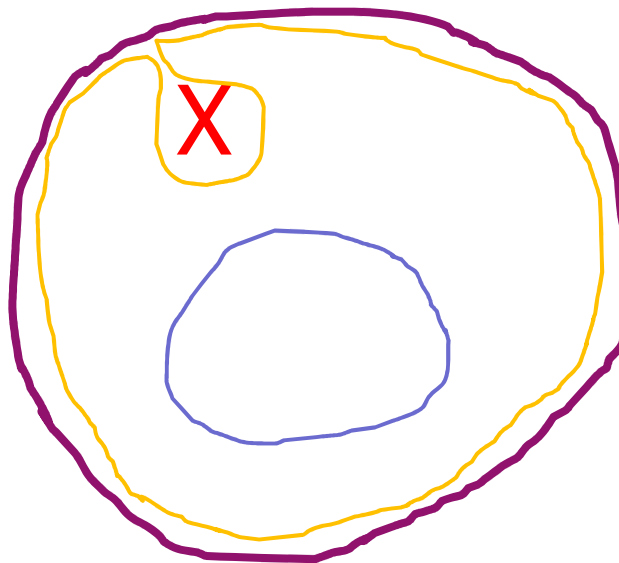
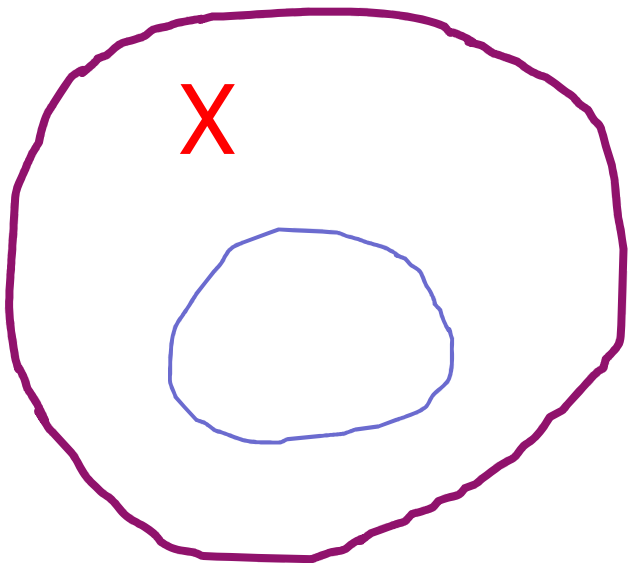

Is there basis for amendments in the application text?

- Claims - product, process
- Product
 - Make, use, dispose of, offer for disposal, import, keep in the UK
- Process
 - Use, offer for use in UK
 - Disposes of, offers to dispose of, uses, imports any **product obtained directly** by means of the process
- Indirect Infringement
 - Supplying an unauthorised person with the means for putting invention into effect
- NB Infringement is territorial

A Typical Day in the Life of a Patent Attorney

PRIVATE PRACTICE	INDUSTRY
Check e-mails and post and record deadlines	Check e-mails and post and record deadlines
Client meetings	Meetings with scientists
Drafting a new application	Meetings with tech transfer
Prosecuting an ongoing application	Meetings with managers
Opposition work Possibly some licence work	Teleconferences with overseas attorneys, colleagues at other sites, other stakeholders (e.g. regulatory)
Teleconferences with overseas attorneys, patent searchers, solicitors, EPO etc.	Work on drafting, prosecution or opposition work or coordinate with outside counsel
Business development	Licence work
Probably less travel, mainly to the EPO	Travel
Variety	Less variety of technical subject matter

Being a patent attorney

- Good work-life balance – mostly
 - Deadline-driven – managing stress
 - Detailed technical and legal opinions
 - Sometimes under significant time pressure



- Well paid! (Private practice figures)
 - Graduate starting salary **£26,700-£28,500**
 - Part-qualified **£41,300-£42,200** (2-3 years)
 - UK qualified **£57,200-£61,000** (3-4 years)
 - UK & European qualified **£61,500-£65,000** (4-5 years)
 - Senior attorney **£87,300-£88,200** (10 years)
 - Bonuses in some firms

Being a patent attorney



- Diverse skill set
 - Scientific analysis
 - Linguistic (written and verbal)
 - Social!



- Opportunity to mix business with science
 - Contact with scientists
 - Involvement with client business
 - Running your own business

- International links





Is a career in patent law right for me?

- Broad interest in science and technology
- Able to reason clearly and logically in writing / orally
- Excellent analytical skills
- Very high attention to detail
- Good people skills for dealing with clients
- Ability to work to tight deadlines
- Willing to commit to further study for professional exams

Becoming a patent attorney

- Scientific degree(s)
- Legal training on the job
- Professional examinations (14 in total, 2-6 hours each)
 - UK Foundation exams (x5)
 - UK patent law, International patent law
 - Basic English law
 - Design & copyright law
 - Principles of Trade Mark law
 - UK Advanced exams (x4)
 - Legal, drafting, amendment, infringement
- European qualifying examinations (EQEs) (x5)
- Duration of training typically 4 to 5 years

Becoming a patent attorney: Exam route

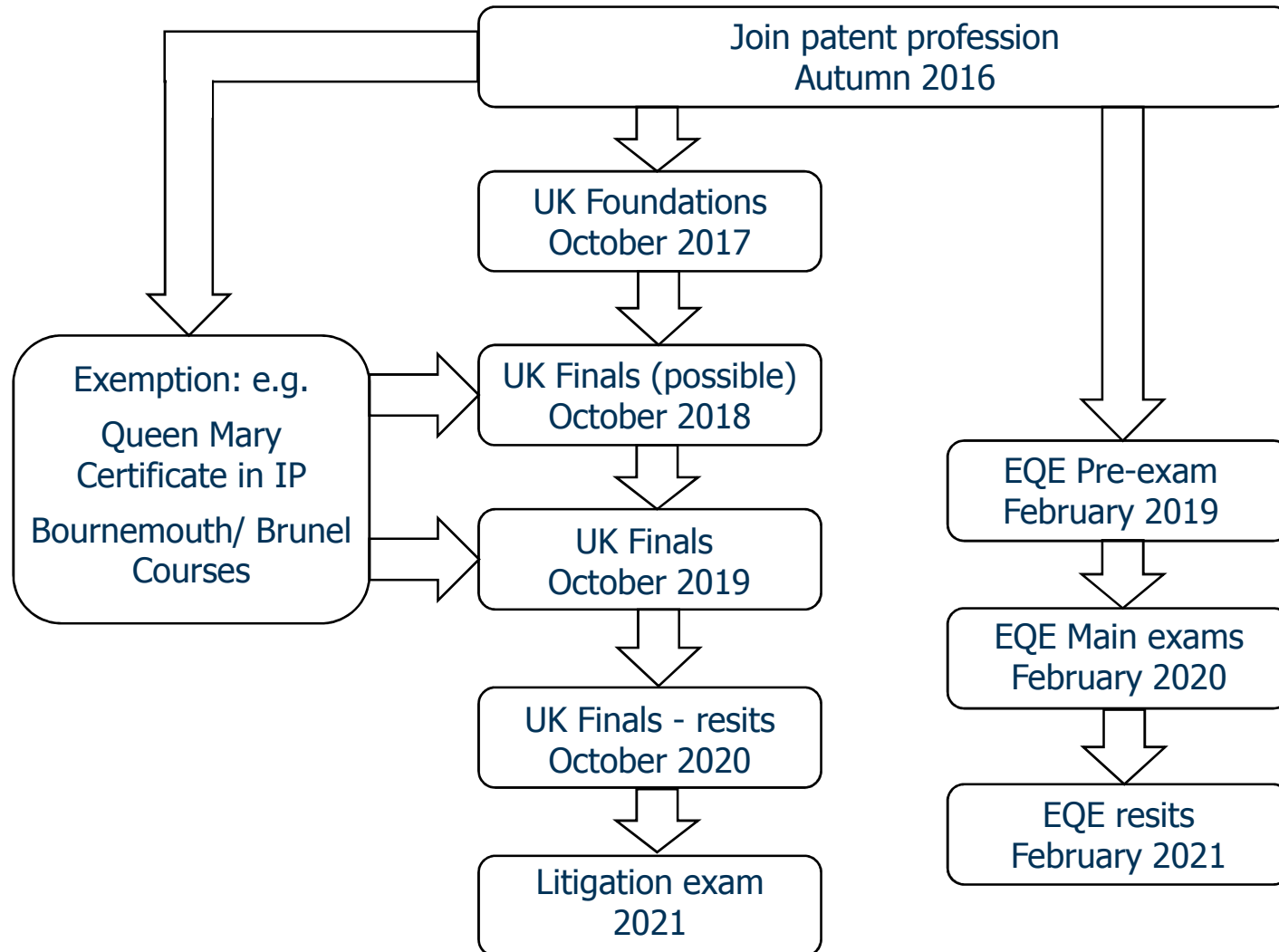

Grammatically correct and typo-free CV and covering letter!!

- Find out who to address your covering letter to
- Highlight how your skills/experience relate to the patent profession

How to get started

- Work experience
- CIPA website www.cipa.org.uk
- Inside Careers (training positions & work experience schemes advertised)
www.insidecareers.co.uk/professions/patent-attorneys
- Prospects www.prospects.ac.uk/job-profiles/patent-attorney
- Direct contact to private firms/corporate departments
- Patent offices – become a patent examiner?
 - UK Intellectual Property Office
 - European Patent Office

Trainee Patent Attorney Interviews

- Things you could get asked:
 - Draft or correct the mistakes in a letter
 - Describe an object e.g. scissors or paperclip
 - Look at a prior art document and a claim, and determine any novel/inventive features and possible amendment options
 - Basic questions related to your technical background
- It might also be worth thinking about your answers to the following questions:
 - Why are you interested in becoming a patent attorney?
 - What do you consider a patent attorney to do on a daily basis?
 - What skills/attributes do you believe are essential in making a good patent attorney?



Thank you – questions?

Meeta Mistry

meetamistry@greavesbrewster.co.uk

Simon Carobene

simoncarobene@greavesbrewster.co.uk